



“Read and Save These Instructions”

Single Tube, Multiple Tube, Mini-Mult, & Area Type

Steam Injection Humidifiers

Installation Instructions

Operation and Maintenance Manual

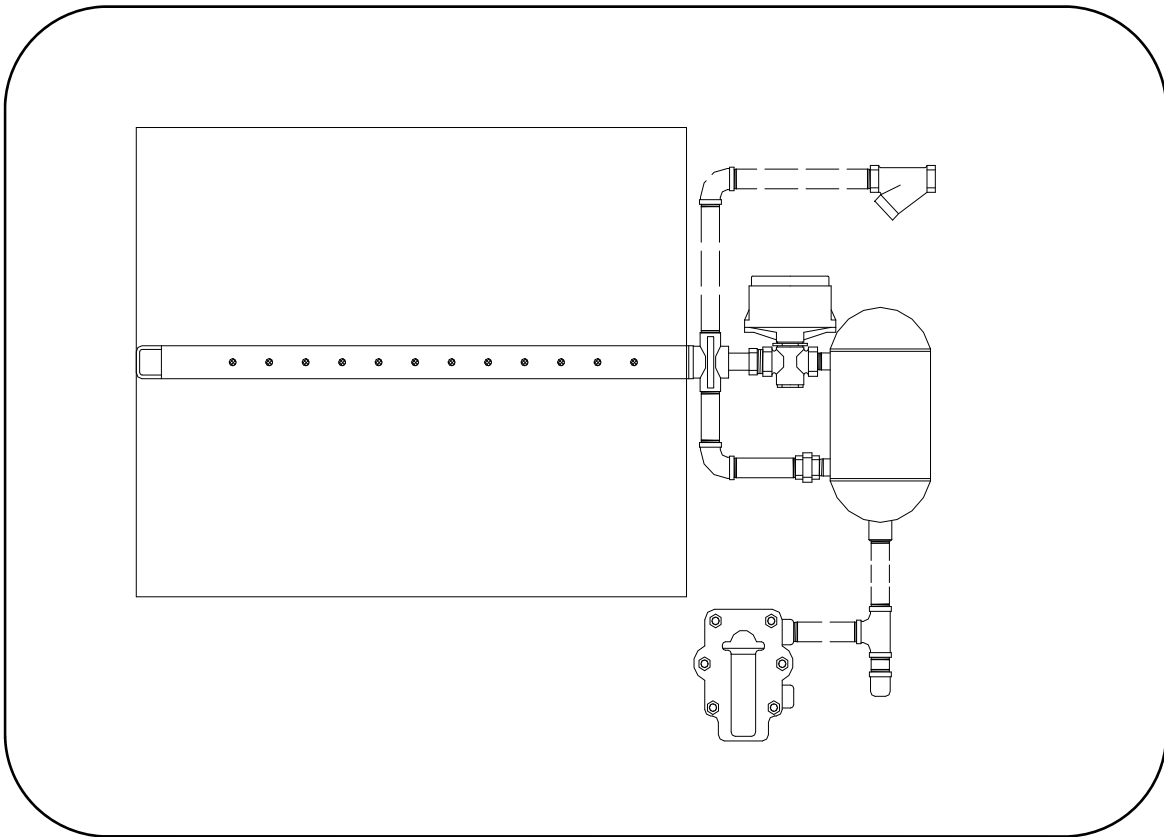

The PURE choice for humidification

Introduction

Table of Contents

Introduction	1
Installation & Piping	2
Tube Adaptor & Temperature Switch	3
Drain Pan & Location	4
Location	5
Location	6
Troubleshooting	7
Maintenance & Installation Tips	8
Maintenance Notes	9
Exploded Parts Drawing	10
Single Tube Parts List	11
Multiple Tube Parts List	12

To the user of PURE Humidifier Co.'s Steam Injection Humidifiers

We at PURE Humidifier Co. thank you for choosing one of our quality products. PURE Humidifier Co. humidifiers are simple to install, operate, and maintain. However, they must be maintained to provide maximum operating efficiency.

PLEASE READ AND FOLLOW ALL INSTRUCTIONS CAREFULLY. PROPER OPERATION AND HUMIDITY CONTROL IS POSSIBLE ONLY WITH PROPER INSTALLATION AND MAINTENANCE.

To ensure proper installation of this product, it must be installed by qualified HVAC and electrical contractors, and must be in compliance with local, state, federal, and governing codes. If installed improperly this product may cause damage to property, severe personal injury, or death as a result of electric shock, burns, and/or fire.

High chloride content in boiler steam condensate carryover can cause chloride stress cracking and chloride pitting in stainless components. Chloride stress corrosion cracking (CSCC) and chloride pitting of stainless steel components is not covered by warranty. Do not use hydrochloric acid descalers or bleach to clean the tank. Consult the factory if you are unsure about which chemical descaler to use.

The PURE Humidifier Co. Warranty

PURE Humidifier Co. guarantees its products to be free from defects in material and workmanship for a period of two years from the date of shipment; provided the product is properly installed, serviced, and put into the service for which it was intended.

PURE Humidifier Co. is obligated under the terms of this warranty to the repair or replacement of the defective part(s), excluding any labor charges, or to refund the purchase price at our option. PURE Humidifier Co. assumes no obligation for incidental or consequential damages. The above provisions are in lieu of all other guarantees, obligations, liabilities or warranties, expressed or implied.



Installation & Piping

Steam Injection Series

1. Injection Tube Installation:

- A. Check to see that the steam emission ports face upstream. If the unit has been pre-assembled at the factory and the direction of steam release is not upstream, simply open the union, remove the nipple/elbow assembly from the tube, rotate 180° and re-install the nipple/elbow assembly.

Humidifiers with injection tubes longer than four feet are shipped with the tube separated from the humidifier body. In this case, assemble the unit with the steam emission ports facing upstream.

EXCEPTION: Some injection tubes are insulated with a fiberglass blanket surrounded by a stainless steel jacket that remains cold in operation. In this case, install the unit with the ports facing downstream to prevent condensate from forming on the cold jacket.

- B. Cut a hole in the duct or plenum slightly larger than the injection tube. Duct plates are furnished to tightly seal around the tube.
- C. Insert injection tube. If tube is horizontal, it should be mounted level. Support outboard end of tube by securing the duct wall with support bolt. (Six inch tubes do not require outboard support.)
- D. Vertical tube models must always be installed with the tube support bracket installed in the upward location to avoid trapping condensate in the outboard end of the injection tube.

2. Piping the Humidifier

- A. The steam supply to the humidifier must always be taken off the top of the steam main, never the side or bottom.
- B. In order for the steam trap to remove condensate, it is essential that pressure in the condensate return line be well below the pressure in the supply line to the humidifier. If the condensate line is pressurized, PURE Humidifier Co. recommends that a back flow prevention device be installed right after the steam trap (by others).

3. Tube Adaptor

All PURE Humidifier Co. single injection tube humidifiers utilize a brass tube for connecting the steam control valve to the injection tube. On single tube units four feet and shorter, the separator valve assembly is assembled to the injection tube. However, on units longer than four feet, the separator/valve assembly is disconnected from the injection tube for shipping. When the injection tube is shipped loose, the separator/valve assembly must be field assembled to the injection tube. The following instructions should be followed when connecting the tube to the separator/valve assembly:

1. Make sure the injection tube and separator/valve assembly is a matched set (the injection tube and separator assembly will have identical tagging from the factory).
2. The o-ring on the tube adaptor must be lubricated with an o-ring lubricant before assembly. The tube adaptor and o-ring are factory attached to the valve (reference the drawing below).
3. Slowly slide the injection tube inner tube over the tube adaptor. **CAUTION** should be exercised to prevent the tube from cutting the o-ring.
4. Align the union halves on the separator/valve assembly and injection tube black iron piping. Tighten the union to a leak-tight fit.

The humidifier is now ready for installation and final piping.

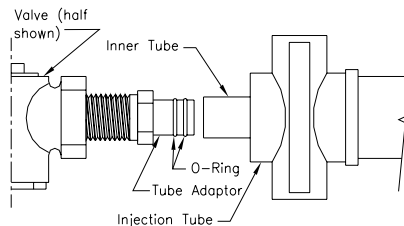

4. Temperature Switch

If temperature switches are used, they should be located between the steam separator and the drain trap to sense the temperature at that point. If the line contains water, the temperature switch will prevent the valve from opening. Please reference temperature switch installation sheet shipped with the order for specific installations instructions.

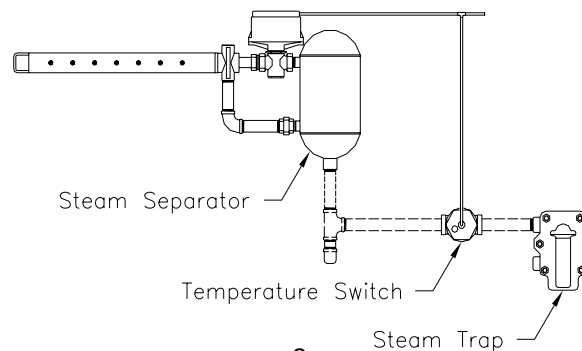



Drain Pan & Location

Steam Injection Series

5. Drain Pans

When the system is operating properly, the humidifier disperses steam free of water. **WARNING:** In the event of failure of some part of the system, such as a flooded steam main or a non-functioning drain trap, it is possible for water to escape through the injection tube. If such a malfunction would cause damage, use of a drain pan is recommended.

6. Location of Injection Tube

- A. Whenever possible, install the injection tube in the center of the duct.
- B. If installing into a duct that is 8 inches or less in height, PURE Humidifier Co. recommends the use of an expanded duct section to prevent restricting the air flow.
- C. While the steam emitted from the injection tube is still visible it can collect on devices in the duct and be a potential source of trouble. It is preferable to locate downstream of these devices. If this is not possible, the humidifier should be located far enough upstream to vanish before making such contact. The following spacing is recommended:
 - 1. Not less than 12 feet upstream from high efficiency filters. Locate high-limit duct humidity controller immediately upstream from the filter.
 - 2. Humidifiers should not be placed less than 3 feet upstream from fan inlets, tees, "ells", turning vanes, discharge grills, or other devices.
 - 3. To guard against faulty readings, do not install humidifier less than 10 feet upstream from temperature controller.
 - 4. When installing in a multi-zone "packaged" air handling system, installation should be in the center of the active air flow and as close to the discharge as possible.

Reference the following five humidifier systems for humidifier location.

System 1

In this simple heating/ventilating system the desired location of the humidifier is downstream from the fan. The use of a high limit duct humidistat is recommended if operating conditions are such that saturation could be reached in the duct. The high limit humidistat should be 12 to 14 feet (365-427 cm) downstream from the humidifier injection tube. A space humidistat controls the humidifier.

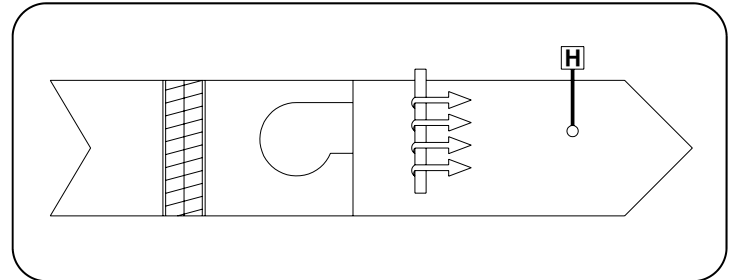

System 2

This is a 100% outside air system with preheat and reheat coils. The desired location of the primary humidifier is downstream from the reheat coil where air temperature is highest. Where operating conditions vary considerably from design, two humidifiers may be used; control is sequenced from a single space or exhaust air duct humidistat. The first humidifier will deliver one-third of the total capacity. The second humidifier is sized for two-thirds of the total capacity. When control is sequenced in this manner, much closer control is achieved.

When outdoor air conditions are milder, the first humidifier will satisfy the space conditions by supplying a portion of the total design capacity. As the outside air becomes colder and humidity demand increases, the second unit begins to open in response to the additional demand. When the humidifiers are sequenced as described, much closer control is achieved over a wide range of outside air conditions and super saturation of the duct at minimum humidification load is avoided. Use of a high-limit controller is desirable.

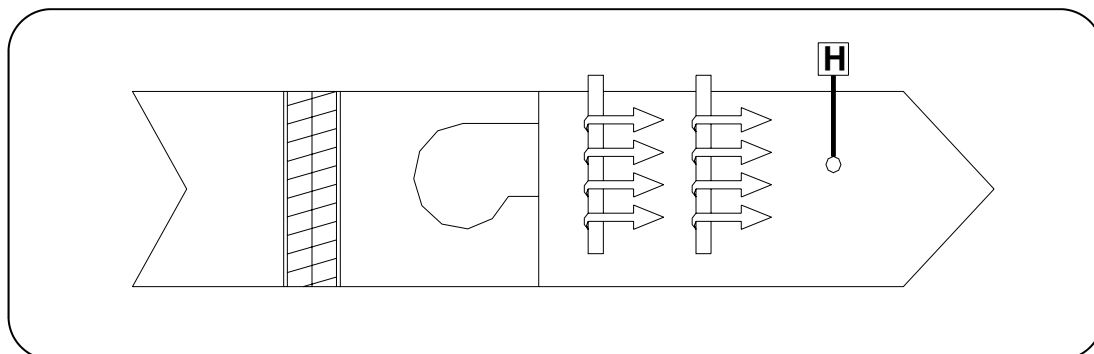

System 3

Shown here is a 100% outside air system using a primary and secondary humidifier. In this system, the primary humidifier is controlled by a duct humidistat 12 to 14 feet (366-427 cm) downstream from the humidifier and at a level that maintains a space condition of about 35% R.H. at 70°F. The secondary humidifier is controlled by a space humidistat. The secondary unit can be sized to boost space R.H. from 35% R.H. to a higher level such as 55% R.H. Combining humidifiers in this manner allows humidity for each zone to be controlled at a level higher than would otherwise be possible.

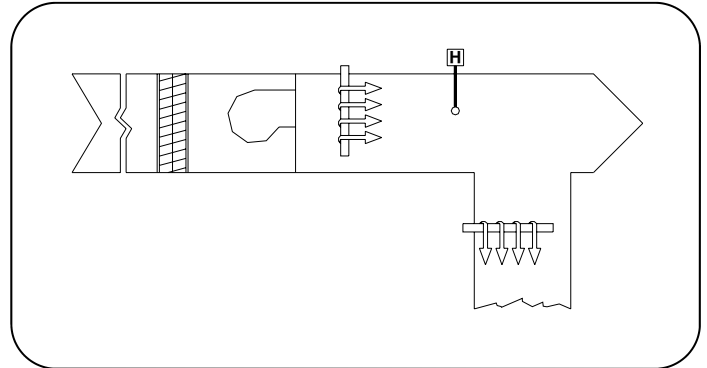

System 4

Here is a high velocity dual duct system. In this system, best results are achieved with primary and booster humidification. The primary humidifier is located as far upstream as possible from the fan and is controlled by a duct humidistat located ahead of the hot and cold deck coils. The booster humidifier is located downstream from the mixing box and is controlled by a humidistat in the space. The primary humidifier should be located no closer than 3 feet (91 cm) from the fan and the booster humidifier no closer than 3 feet (91 cm) from the grill. In both cases, the use of multiple injection tube units should be considered.

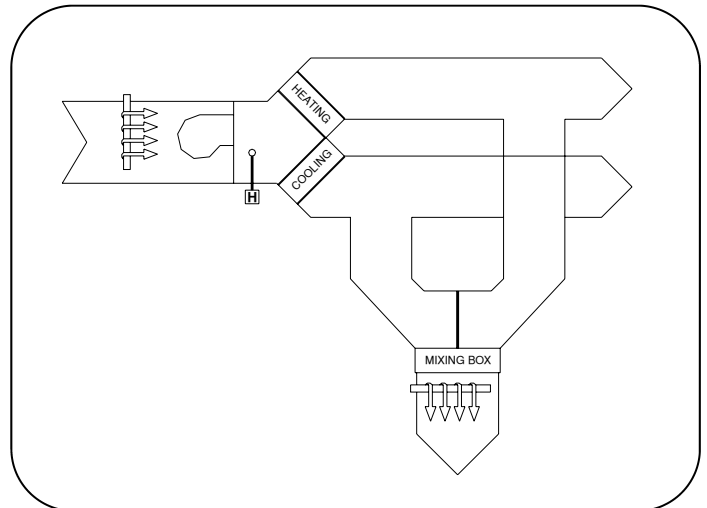

System 5

System 5 is a simple face and bypass unit. The humidifier is located downstream from the damper section so moisture enters the air stream in the area where best mixing and air temperature conditions exist.

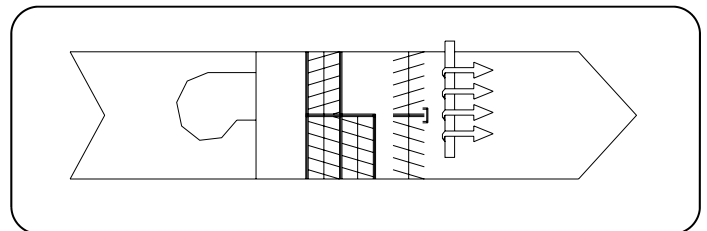



Troubleshooting

Steam Injection Series

TOO MUCH HUMIDITY

1. Humidity controller out of calibration.
2. Valve stem sticking.
3. Valve spring broken.
4. Foreign matter preventing valve from closing.

TOO LITTLE HUMIDITY

1. Strainer screen plugged.
2. Stop valve not fully open.
3. Silencer media dirty.
4. Humidity controller out of calibration.
5. Inadequate steam pressure.
6. Undersized humidifier.
7. Automatic control valve not opening fully.
 - A) Pneumatic valve operator leaking air.
 - B) Valve stem sticking.

HUMIDIFIER DISCHARGES WATER

1. Faulty drainage:
 - A) Return line pressure greater than humidifier pressure.
 - B) Return line flooded.
 - C) Dirty steam trap.
 - D) Too much vertical lift.
 - E) Wrong type steam trap, float type must be used.
2. Faulty steam supply:
 - A) Humidifier supply not taken from top of main.
 - B) Too low (below 2 psi) steam pressure.
 - C) Long, untrapped supply line.
 - D) Steam main flooded due to priming boiler.

HUMIDITY SWINGS ABOVE AND BELOW CONTROL POINT

1. Boiler pressure swings too widely.
2. Faulty or inaccurate humidity controller.
3. Humidifier oversized.
4. Humidity controller in poor sensing location.
5. Pressure reducing valve not controlling accurately



Maintenance & Installation Tips

Steam Injection Series

MAINTENANCE

1. **Separator** – No maintenance required.
2. **Injection tube** – No maintenance required.
3. **Valve - Pneumatic** – Should be inspected annually to be sure that a) the diaphragm in the actuator is not leaking air, b) the valve closes off tightly, c) the stem packing is not leaking steam.
Valve - Electric – Should be inspected annually to confirm that the stem packing is not leaking and that the valve closes tightly.
Valve - Solenoid – Requires no maintenance.
4. **Strainer** – Clean screen a few days after humidifier is put in operation and annually hereafter.
5. **Steam trap** – Inspect annually.

INSTALLATION TIPS

Condensate Return Line

In order for the steam trap to remove condensate, it is essential that pressure in the condensate return line be substantially below the steam supply pressure. In the event the return line is at a higher elevation than the steam trap, the trap should be drained to a floor drain or the condensate, an intermittent discharge trap, such as an inverted bucket type, should be used. Every 2 psig (13.8 kpa) of steam pressure will elevate the condensate one foot (30.5 cm). Also, a check valve must be installed on the outlet of the steam trap to prevent back flow of the elevated condensate into the humidifier.

Expanded Duct Section

To avoid restricting air flow in a duct 8 inches (20.3 cm) or less in height, use of an expanded duct section is recommended.

Proper Length Injection Tubes

For best dissipation of the steam into the air stream, always use injection tubes that fully span the widest dimension of the duct.

Vertical Tube Humidifiers

In those installations where the duct is taller than it is wide, a vertical tube humidifier may be used to gain tube length. NOTE: Vertical tube humidifiers must always be installed with the tube(s) pointing upwards to avoid trapping condensate in the outboard end of the injection tube.

Insulated Injection Tubes

Where specifications require, insulated injection tubes are available. The insulation is 1/2" (1.3 cm) fiberglass covered with a 24 gauge stainless steel jacket. NOTE: Insulated injection tubes must be installed with the steam emitting with the air flow to prevent condensation on the outer insulation jacket.

Fan Interlock Switch

PURE Humidifier Co. recommends the use of an air flow proving switch or fan interlock to prove air flow prior to humidifier cooperation. Humidifier operation without air flow will result in over-saturation of the air stream. Air flow proving switches are available as optional equipment from your PURE Humidifier Co. representative.

High-Limit Humidistat

PURE Humidifier Co. recommends the use of a duct high-limit humidistat to prevent humidifier operation when the duct humidity level exceeds 85% relative humidity. Humidifier operation above 85% relative humidity can result in over-saturation of the air stream. High-limit humidistats are available as optional equipment from your PURE Humidifier Co. representative.

Temperature Interlock Switch

PURE Humidifier Co. recommends the use of a interlock temperature switch on applications with steam pressures below 5 psi (34.5 kpa) or as a safety switch to prevent humidifier operation in the case of a boiler or trap malfunction. Interlock temperature switches (pneumatic or electric) are available as optional equipment from your PURE Humidifier Co. representative.



PURE
Humidifier

Maintenance Notes
Steam Injection Series

Maintenance Performed	Maintenance Notes	Date	By

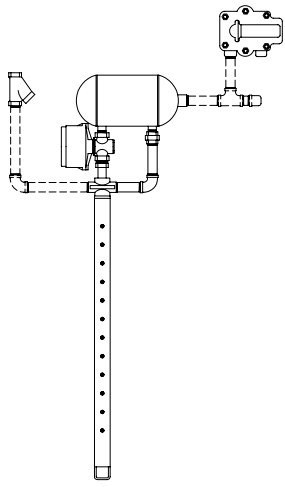

Assembled Single Tube Unit
(Dotted line piping is by others)

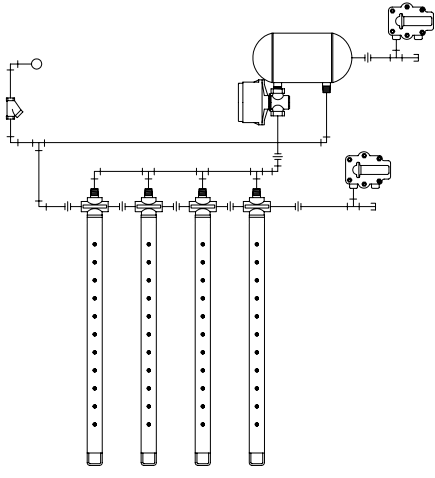

Assembled Multiple Tube Unit
(Line piping is by others)

⑥ Strainer

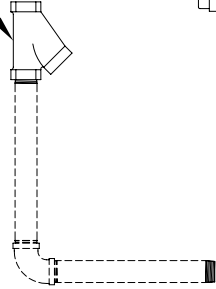

③ Actuator

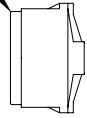

② Valve

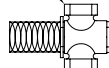

① Separator

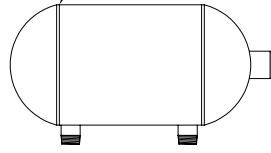

O-Rings (2)
(Single Tube Only)

⑦



Injection Tube(s)

④

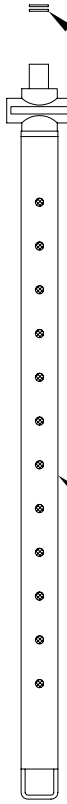

Tube Adaptor
(Single Tube Only)

⑧

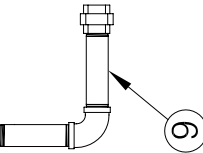

Pipe Fitting Assembly
(Single Tube Only)

⑨

Trap(s)

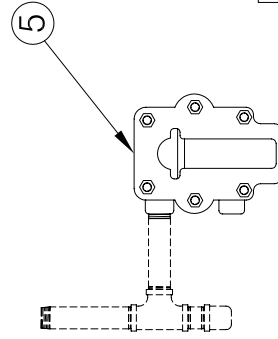

Title: SI Series Steam Injection Humidifier Parts Identification

Scale: No Scale

Date: June 23, 2008

Drwn: P. R. G.

Dwg No:

SI Parts List

**PURE Humidifier Co. "SI" Steam Injection
Series, Single Tube Humidifiers
Parts List & Two Year Recommended Spare Parts**



Model 50 Single Tube Humidifier

Item No.	Description	Parts No.	Qty per Unit	Rec. Spare Qty
1	Model 50 Separator	S5011	1	
2	Valve	A	1	
3	Actuator	A	1	
4	Injection Tube	A	1	
5	3/4" NPT Trap	A	1	
6	1/2" Strainer	15140	1	
7	Tube Adaptor	15519	1	
8	O-Rings	15156	2	
9	Pipe fitting assembly	A	1	

Model 60 Single Tube Humidifier

Item No.	Description	Parts No.	Qty per Unit	Rec. Spare Qty
1	Model 60 Separator	S6012	1	
2	Valve	A	1	
3	Actuator	A	1	
4	Injection Tube	A	1	
5	3/4" NPT Trap	A	1	
6	3/4" Strainer	15141	1	
7	Tube Adaptor	15236	1	
8	O-Rings	15158	2	
9	Pipe fitting assembly	A	1	

Model 70 Single Tube Humidifier

Item No.	Description	Parts No.	Qty per Unit	Rec. Spare Qty
1	Model 70 Separator	S7012	1	
2	Valve	A	1	
3	Actuator	A	1	
4	Injection Tube	A	1	
5	3/4" NPT Trap	A	1	
6	3/4" Strainer	15141	1	
7	Tube Adaptor	15236	1	
8	O-Rings	15158	2	
9	Pipe fitting assembly	A	1	

Model 80 Single Tube Humidifier

Item No.	Description	Parts No.	Qty per Unit	Rec. Spare Qty
1	Model 80 Separator	S8015	1	
2	Valve	A	1	
3	Actuator	A	1	
4	Injection Tube	A	1	
5	3/4" NPT Trap	A	1	
6	1 1/4" Strainer	15143	1	
7	Tube Adaptor	15241	1	
8	O-Rings	15159	2	
9	Pipe fitting assembly	A	1	

NOTES/CODES:

A = Part Number is job specific.

When ordering replacement or spare parts, please have the following information available: Model Number, Capacity & Steam Pressure, Serial Number, and any options (ie, modulating humidistats, or temperature switch etc.)

**PURE Humidifier Co. "SI" Steam Injection
Series, Multiple Tube Humidifiers
Parts List & Two Year Recommended Spare Parts**



Model 50 Multiple Tube Humidifier

Item No.	Description	Parts No.	Qty per Unit	Rec. Spare Qty
1	Model 50 Separator	M5011	1	
2	Valve	A	1	
3	Actuator	A	1	
4	Injection Tube	A	A	
5	3/4" NPT Trap	A	2	
6	1/2" Strainer	15140	1	

Model 60 Multiple Tube Humidifier

Item No.	Description	Parts No.	Qty per Unit	Rec. Spare Qty
1	Model 60 Separator	M6012	1	
2	Valve	A	1	
3	Actuator	A	1	
4	Injection Tube	A	A	
5	3/4" NPT Trap	A	2	
6	3/4" Strainer	15141	1	

Model 70 Multiple Tube Humidifier

Item No.	Description	Parts No.	Qty per Unit	Rec. Spare Qty
1	Model 70 Separator	M7014	1	
2	Valve	A	1	
3	Actuator	A	1	
4	Injection Tube	A	A	
5	3/4" NPT Trap	A	2	
6	1" Strainer	15142	1	

Model 80 Multiple Tube Humidifier

Item No.	Description	Parts No.	Qty per Unit	Rec. Spare Qty
1	Model 80 Separator	A	1	
2	Valve	A	1	
3	Actuator	A	1	
4	Injection Tube	A	A	
5	3/4" Trap	A	2	
6	1 1/2" Strainer	15144	1	

Model 90 Multiple Tube Humidifier

Item No.	Description	Parts No.	Qty per Unit	Rec. Spare Qty
1	Model 90 Separator	M9019	1	
2	Valve	A	1	
3	Actuator	A	1	
4	Injection Tube	A	A	
5	3/4" NPT Trap	A	2	
6	2" Strainer	15145	1	

NOTES/CODES:

A = Part Number is job specific.
When ordering replacement or spare parts, please have the following information available: Model Number, Capacity and Steam pressure, Serial Number, and any options (ie, modulating humidistats, or temperature switch etc.)



141 Jonathan Blvd. North
Chaska, MN 55318
Tel: (952) 368-9335 Fax: (952) 368-9338
www.purehumidifier.com